

SINGER

701-7 & 701-9

LIST OF PARTS



SINGER^{**} KNIFE GRINDERS Nos. 701-7 and 701-9

THE SINGER MANUFACTURING COMPANY

INSTRUCTIONS FOR ORDERING

In ordering from this list, use ONLY the part NUMBER in the FIRST column.

The number stamped on a Sewing Machine Part is in every case the number of the single part only.

Every combination of parts sent out as such has its specific number, which, although not stamped on the parts, must be used when ordering the combination.

Each number always indicates the SAME PART in whatever list it appears, or for whatever machine.

The letters after some of the numbers indicate the style of finish only, as follows:

A- Hardened, Polished, Nickel Plated and Buffed

B- Polished, Nickel Plated and Buffed

C- Hardened Only

D- Polished Only

E- Soft, Not Polished

F- Hardened and Polished

G- Bright Rumbled and Nickel Plated

H- Blued

J- Nickel Plated Only

K- Hardened and Nickel Plated

L- Brass Plated

M- Oxidized

R- Phosphate Coating Formed on Surface of Iron or Steel

S- Cadmium Plated

T- Copper Plated

U- Zinc Plated

V- Silver Plated

W- Polished and Nickel Plated

X- Black Oxide for Iron and Steel

Y- Black Nickel Plated Only

Z- Chromium Plated

A.A- Buffed and Chromium Plated

A.B- Hardened, Polished, Buffed and Chromium Plated

A.E- Hardened, Bright Rumbled and Nickel Plated

A.F- Hardened, Bright Rumbled, Nickel Plated
Bright Rumbled and Chromium Plated

A.G- Alumilite (Plain)

A.H- Alumilite (Dyed) Color Must be Stated

A.J- Polished, Nickel Plated and Chromium Plated

A.K- Hardened, Polished, Nickel Plated and Chromium Plated

A.L- Heat Treated for Toughness

A.L.D- Heat Treated for Toughness and Polished

A.L.X- Heat Treated for Toughness and Black Oxide

INSTRUCTIONS FOR ORDERING

- A.S—Black Moulded Phenolic
 A.T—Beige Moulded Phenolic
 A.U—Brown Moulded Phenolic
 A.W—Hardened then Flame Coated with Tungsten Carbide
 B.A—Chrome Nickel Satin Finish
 B.B—Hardened and Chrome Nickel, Satin Finished
 C.R—Hardened and Phosphate Coating Formed on Surface of Steel
 F.J—Hardened, Polished and Nickel Plated
 T.A—Hardened, Polished, Copper and Nickel Plated and Buffed
 T.B—Copper and Nickel Plated and Polished
 T.J—Copper and Nickel Plated Only
 T.K—Hardened, Copper and Nickel Plated
 T.L—Copper and Brass Plated
 T.M—Copper Plated and Oxidized
 X.C—Hardened and Black Oxide for Iron and Steel
 Z.A—Hardened, Polished Nickel Plated, Buffed and Chromium Plated
 Z.B—Polished, Nickel Plated, Buffed and Chromium Plated
 Z.C—Hardened and Chromium Plated
 Z.D—Polished and Chromium Plated
 Z.G—Bright Rumbled, Nickel Plated, Bright Rumbled and Chromium Plated
 Z.J—Nickel and Chromium Plated
 Z.T—Copper and Chromium Plated

These letters **MUST BE USED** when they appear in the list; and **AFTER** the number as in the list.

In this series:

1 to 1500, 50001 to 51500 and 140001 to 142,000 are screw numbers

1501 to 1800 and 51500 to 51800 are nut numbers

1801 to 2000 and 51801 to 52000 are roller numbers

2001 to 50000 and 52001 to 140000 and 142001 to 190000 are Sewing Machine Parts, 190001 and upward are numbers of Electrical Parts.

The figures in the second column refer only to the plates, illustrating the parts, and are **NOT TO BE USED** in ordering.

Parts marked with an asterisk (*) are furnished only when repairs are made at the factory.

LIST OF PARTS COMPLETE FOR

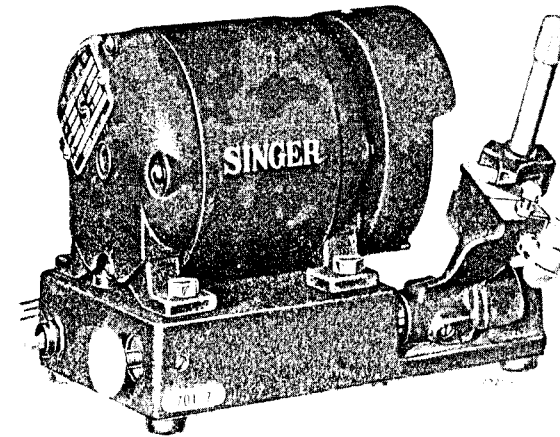

KNIFE GRINDER 701-7

No.	Plate	Name
888071	22955	Capacitor
151040	22955	Capacitor Clamp
191E	22955	Capacitor Clamp Screw
893706	-----	Capacitor Insulation (paper)
151041	22956	Grinding Wheel
151042	22956	Grinding Wheel Adaptor with two 140434C
140434C	22956	Grinding Wheel Adaptor Set Screw (2)
151043	22956	Grinding Wheel Clamping Nut
151044	22956	Grinding Wheel Clamping Nut Washer
151045	22956	Grinding Wheel Guard
50777R	22955	Grinding Wheel Guard Screw (3)
151046	22955	Knife Grinder Base with 1448AL, 151047, wood screw 3/4 in. No. 10 R.H.B. and wood screw 2 in. No. 10 R.H.B.
151047	22955	Knife Grinder Base Plug
151048	22955	Knife Grinder Base Bottom Cover
1454R	22955	Knife Grinder Base Bottom Cover Screw (3)
45780	22955	Knife Grinder Base Cushion (rubber) (4) ..
999R	22955	Knife Grinder Base Cushion Screw (4)
1698J	22955	Knife Grinder Base Cushion Screw Nut
151130	22957	Knife Grinder Knife Carriage with 1337C, 1700J, 50364C, 50552J and 151140
151131	-----	Knife Grinder Knife Carriage 151130 with 650K, 1534J, 24210, 151051, 151055, 151132 and 151133

From the Library of Diamond Needle Corp

PARTS FOR KNIFE GRINDER 701-7

No.	Plate	Name
650K	22957	Knife Grinder Knife Carriage Adjusting Thumb Screw.....
151050	22957	Knife Grinder Knife Carriage Adjusting Thumb Screw Bushing
1448AL	22957	Knife Grinder Knife Carriage Adjusting Thumb Screw Bushing Set Screw
151051	22957	Knife Grinder Knife Carriage Handle
151052	22957	Knife Grinder Knife Carriage Shaft
140041	22957	Knife Grinder Knife Carriage Shaft End Screw
17738	22957	Knife Grinder Knife Carriage Shaft End Screw Washer
151053	22957	Knife Grinder Knife Carriage Shaft Friction Spring
1337C	22957	Knife Grinder Knife Carriage Shaft Set Screw
151132	22957	Knife Grinder Knife Clamping Bracket
50552	22957	Knife Grinder Knife Clamping Bracket Position Screw
151055	22957	Knife Grinder Knife Clamping Bracket Spring
151133	22957	Knife Grinder Knife Holder.....
1534J	22957	Knife Grinder Knife Holder Thumb Nut.....
24210	22957	Knife Grinder Knife Holder Thumb Nut Washer
151140	22957	Knife Grinder Knife (narrow) Position Bracket
50364C	22957	Knife Grinder Knife (narrow) Position Bracket Screw
1700J	22957	Knife Grinder Knife (narrow) Position Bracket Screw Nut
820225	22958	Lead (only) 12 ft. long
820341	22958	Lead with Plug complete Nos. 965225 and 820225, 980335
194717	22955	Lead Strain Relief
965225	22958	Lead Plug
980335	22958	Lead Terminal
984663	22955	Lead Insulating Bushing
965105	22955	Lead Connector
FBE83-15-1	22955	Motor
984662	22955	Motor Lead Insulating Bushing
140041AL	22955	Motor Screw (4)
820342	-----	Toggle Switch complete with 2 leads

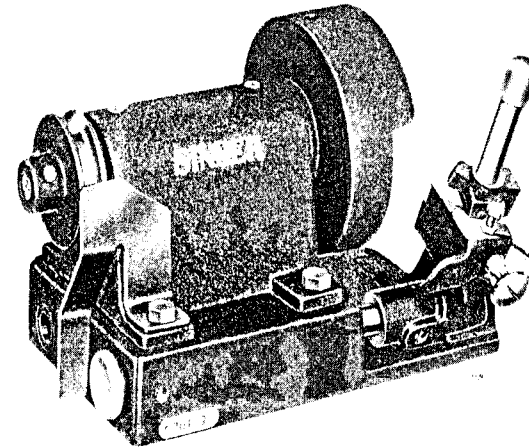
LIST OF PARTS COMPLETE
FOR

KNIFE GRINDER 701-9

No.	Plate	Name
151046	22959	Base with 1448AL, 151047, wood screw 3/4 in. No. 10 R.H.B. and wood screw 2 in. No. 10 R.H.B.....
151047	22959	Base Plug
151126	22959	Belt Guard
151041	22956	Grinding Wheel
151042	22956	Grinding Wheel Adaptor with two 140434C
140434C	22956	Grinding Wheel Adaptor Set Screw (2).....
151043	22956	Grinding Wheel Clamping Nut.....
151044	22956	Grinding Wheel Clamping Nut Washer.....
151045	22956	Grinding Wheel Guard.....
50661R	22956	Grinding Wheel Guard Screw.....
151127	22956	Grinding Wheel Shaft
45704	22959	Grinding Wheel Shaft Bushing (2).....
151128	22959	Grinding Wheel Shaft Housing
151129	-----	Grinding Wheel Shaft Housing 151128 with two each 45704 and 46224
140041AL	22959	Grinding Wheel Shaft Housing Screw (4)....
46224	22959	Grinding Wheel Shaft Oil Cup (2)
151130	22957	Knife Carriage with 1337C, 1700J, 50364C, 50552J and 151140
151131	-----	Knife Carriage 151130 with 650K, 1534J, 24210, 151051, 151055, 151132 and 151133
650K	22957	Knife Carriage Adjusting Thumb Screw

PARTS FOR KNIFE GRINDER 701-9

No.	Plate	Name
151050	22957	Knife Carriage Adjusting Thumb Screw Bushing
1448AL	22959	Knife Carriage Adjusting Thumb Screw Bushing Set Screw
151051	22957	Knife Carriage Handle
151052	22957	Knife Carriage Shaft
140041AL	22957	Knife Carriage Shaft End Screw
17738	22957	Knife Carriage Shaft End Screw Washer ..
151053	22957	Knife Carriage Shaft Friction Spring
1337	22957	Knife Carriage Shaft Set Screw
151132	22957	Knife Clamping Bracket
50552J	22957	Knife Clamping Bracket Position Screw ..
151055	22957	Knife Clamping Bracket Spring
151133	22957	Knife Holder
1534J	22957	Knife Holder Thumb Nut
24210	22957	Knife Holder Thumb Nut Washer
151140	22957	Knife (narrow) Position Bracket
50364C	22957	Knife (narrow) Position Bracket Screw ..
1700J	22957	Knife (narrow) Position Bracket Screw Nut
151134	22956	Pulley with two 448AL
448AL	22956	Pulley Set Screw (2)

NUMERICAL LIST OF PARTS

No.	Plate	Name
191E	22955	Knife Grinder Capacitor Clamp Screw for 701-7 Machine
448AL	22956	Knife Grinder Pulley Set Screw for 151134
650K	22957	Knife Grinder Knife Carriage Adjusting Thumb Screw for 151131
999R	22955	Knife Grinder Base Cushion Screw for 701-7 Machine
1337C	22957	Knife Grinder Knife Carriage Shaft Set Screw for 151130
1448AL	22957	Knife Grinder Knife Carriage Adjusting Thumb Screw Bushing Set Screw for 151046
1454R	22955	Knife Grinder Base Bottom Cover Screw for 701-7 Machine
1534J	22957	Knife Grinder Knife Holder Thumb Nut for 151131
1698J	22955	Knife Grinder Base Cushion Screw Nut for 701-7 Machine
1700J	22957	Knife Grinder Knife (narrow) Position Bracket Screw Nut for 151130
17738	22957	Knife Grinder Knife Carriage Shaft End Screw Washer for 701-7 and 701-9 Machines
24210	22957	Knife Grinder Knife Holder Thumb Nut Washer for 151131
45704	22959	Knife Grinder Grinding Wheel Shaft Bushing for 151129
45780	22955	Knife Grinder Base Cushion (rubber) for 701-7 Machine
46224	22959	Knife Grinder Grinding Wheel Shaft Oil Cup for 151129
50364C	22957	Knife Grinder Knife (narrow) Position Bracket Screw for 151130
50552J	22957	Knife Grinder Knife Clamping Bracket Position Screw for 151130
50661R	22956	Knife Grinder Grinding Wheel Guard Screw for 701-9 Machine
50777R	22955	Knife Grinder Grinding Wheel Guard Screw for 701-7 Machine
140041AL	22959	Knife Grinder Grinding Wheel Shaft Housing Screw for 701-9 Machine
140041AL	22957	Knife Grinder Knife Carriage Shaft End Screw for 701-7 and 701-9 Machines
140041AL	22955	Knife Grinder Motor Screw for 701-7 Machine
140434C	22956	Knife Grinder Grinding Wheel Adaptor Set Screw for 151042
151040	22955	Knife Grinder Capacitor Clamp for 701-7 Machine
151041	22956	Knife Grinder Grinding Wheel for 701-7 and 701-9 Machines

NUMERICAL LIST OF PARTS

No.	Plate	Name
151042	22956	Knife Grinder Grinding Wheel Adaptor with two 140434C, for 701-7 and 701-9 Machines
151043	22956	Knife Grinder Grinding Wheel Clamping Nut for 701-7 and 701-9 Machines
151044	22956	Knife Grinder Grinding Wheel Clamping Nut Washer for 701-7 and 701-9 Machines
151045	22956	Knife Grinder Grinding Wheel Guard for 701-7 and 701-9 Machines
151046	22955	Knife Grinder Base with 1448AL, 151047, wood screw 3/4 in. No. 10 R.H.B. and wood screw 2 in. No. 10 R.H.B., for 701-7 and 701-9 Machines
151047	22955	Knife Grinder Base Plug for 151046
151048	22955	Knife Grinder Base Bottom Cover for 701-7 Machine
151050	22957	Knife Grinder Knife Carriage Adjusting Thumb Screw Bushing for 701-7 and 701-9 Machines
151051	22957	Knife Grinder Knife Carriage Handle for 151131
151052	22957	Knife Grinder Knife Carriage Shaft for 701-7 and 701-9 Machines
151053	22957	Knife Grinder Knife Carriage Shaft Friction Spring for 701-7 and 701-9 Machines
151055	22957	Knife Grinder Knife Clamping Bracket Spring for 151131
151126	22959	Knife Grinder Belt Guard for 701-9 Machine
151127	22956	Knife Grinder Grinding Wheel Shaft for 701-9 Machine
151128	22959	Knife Grinder Grinding Wheel Shaft Housing for 151129
151129	-----	Knife Grinder Grinding Wheel Shaft Housing 151128 with two each 45704 and 46224, for 701-9 Machine
151130	22957	Knife Grinder Knife Carriage with 1337C, 1700J, 50364C, 50552J and 151140, for 151131
151131	-----	Knife Grinder Knife Carriage 151130 with 650K, 1534J, 24210, 151051, 151132 and 151133, for 701-7 and 701-9 Machines
151132	22957	Knife Grinder Knife Clamping Bracket for 151131
151133	22957	Knife Grinder Knife Holder for 151131
151134	22956	Knife Grinder Pulley with two 448AL, for 701-9 Machine
151140	22957	Knife Grinder Knife (narrow) Position Bracket for 151130
194717	22955	Knife Grinder Lead Strain Relief for 701-7 Machine

NUMERICAL LIST OF PARTS

No.	Plate	Name
820225	22958	Lead (only) 12 ft. long, for 820341
820341	22958	Knife Grinder Lead with Plug complete, for 701-7 Machine, Nos. 820225, 965225 and 980335
820342	-----	Knife Grinder Toggle Switch complete, with two leads for 701-7 Machine
888071	22955	Knife Grinder Capacitor for 701-7 Machine
893706	-----	Knife Grinder Capacitor Insulation (paper) for 701-7 Machine
965105	22955	Knife Grinder Lead Connector for 701-7 Machine
965225	22958	Lead Plug for 820341
980335	22958	Knife Grinder Lead Terminal for 701-7 Machine
984662	22955	Knife Grinder Motor Lead Insulating Bushing for 701-7 Machine
984663	22955	Knife Grinder Lead Insulating Bushing for 701-7 Machine
FBE83-15-1	22955	Knife Grinder Motor for 701-7 Machine

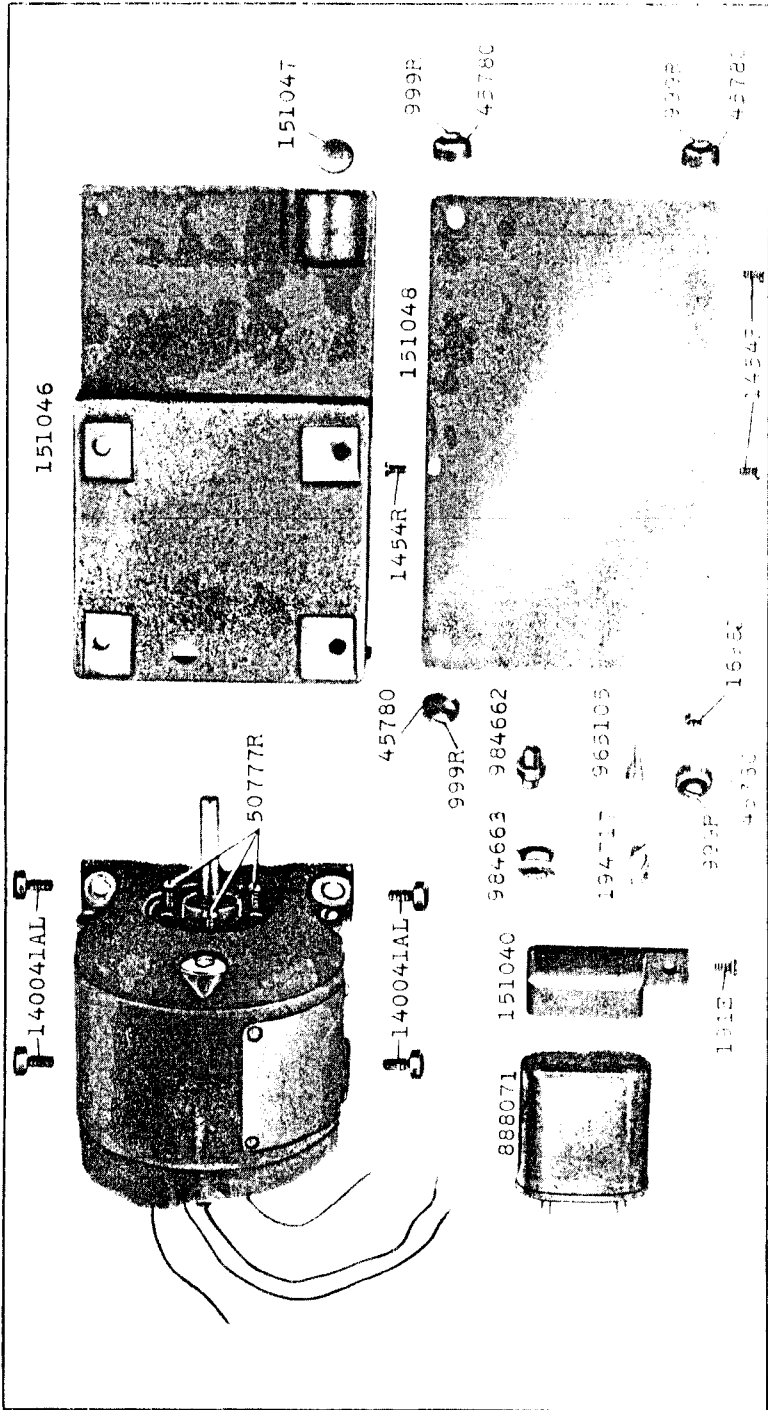

22956-1/2

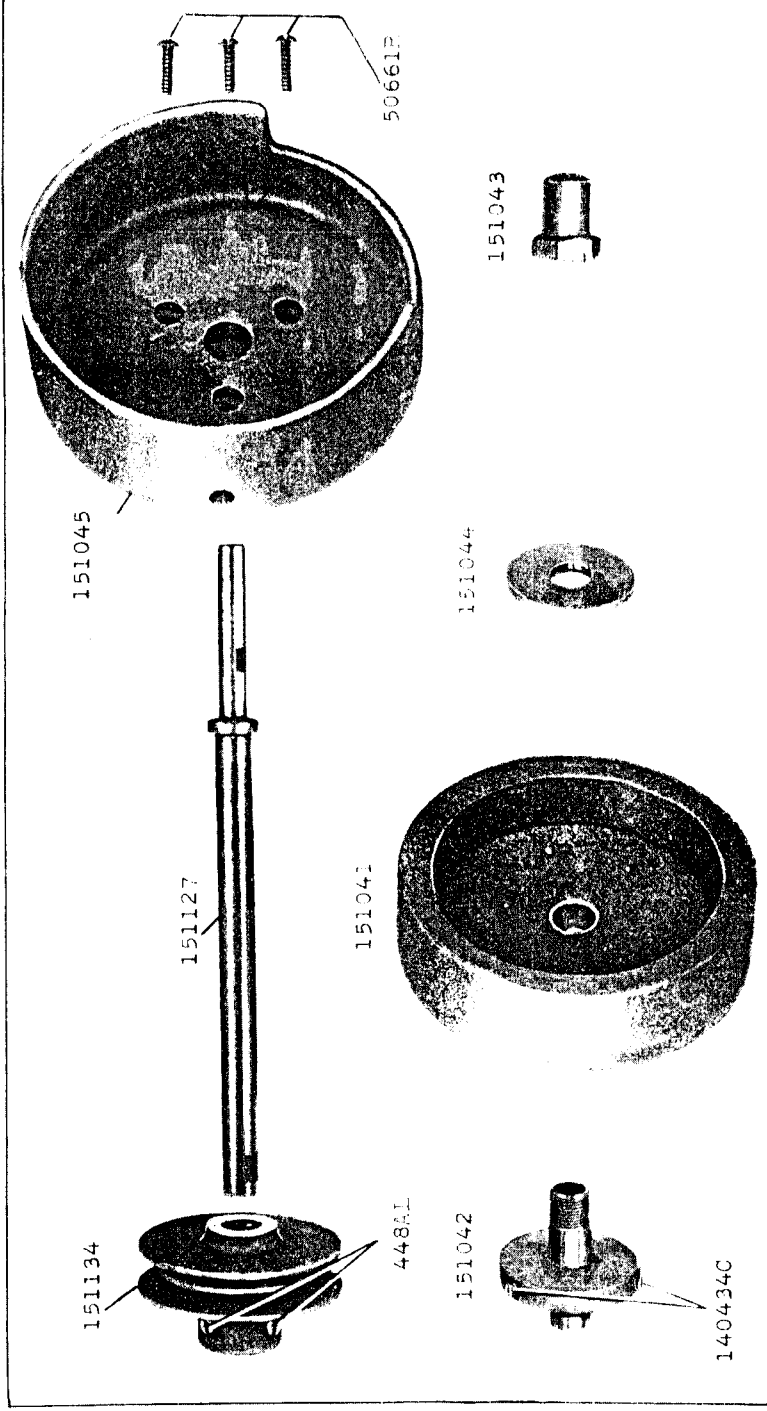

22957-1/2

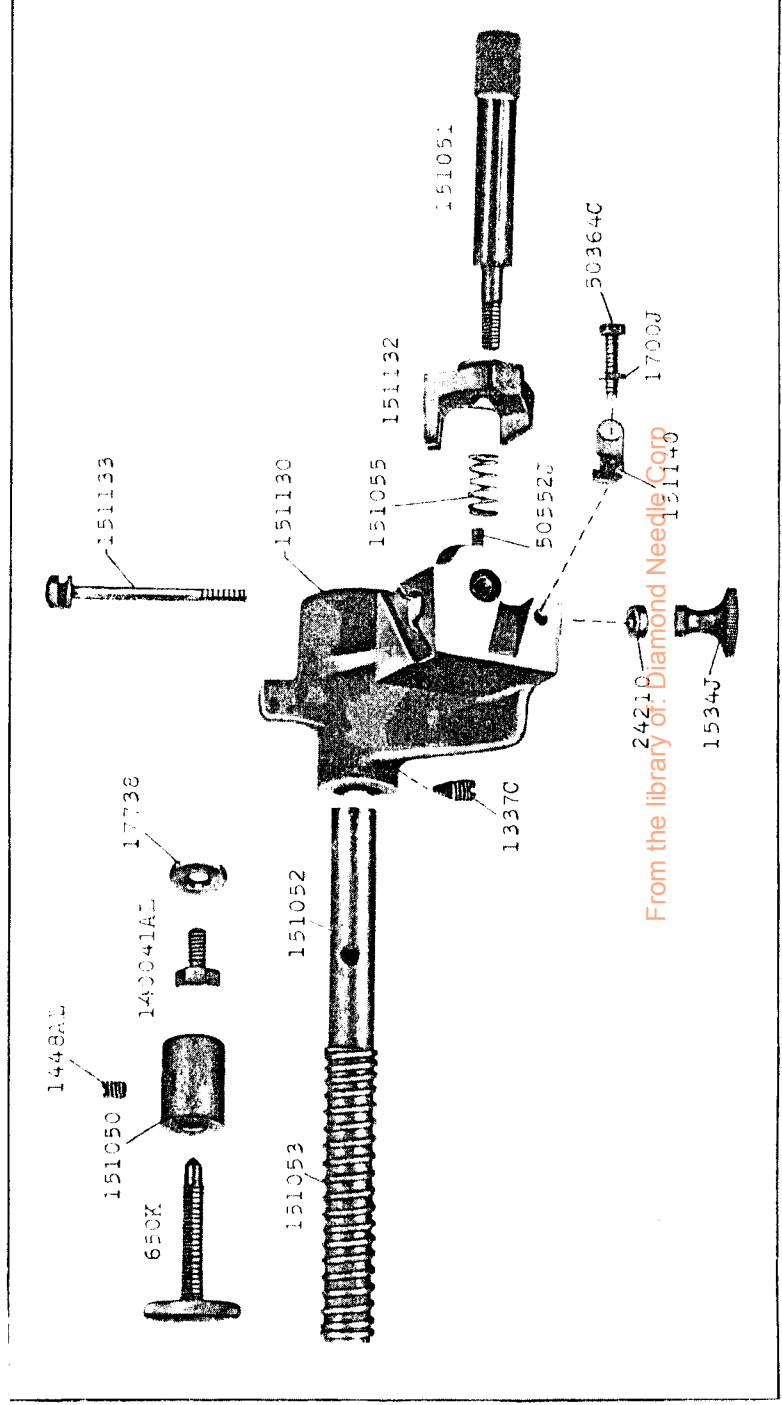

From the library of Diamond Needle Corp

22958-1/2
820341

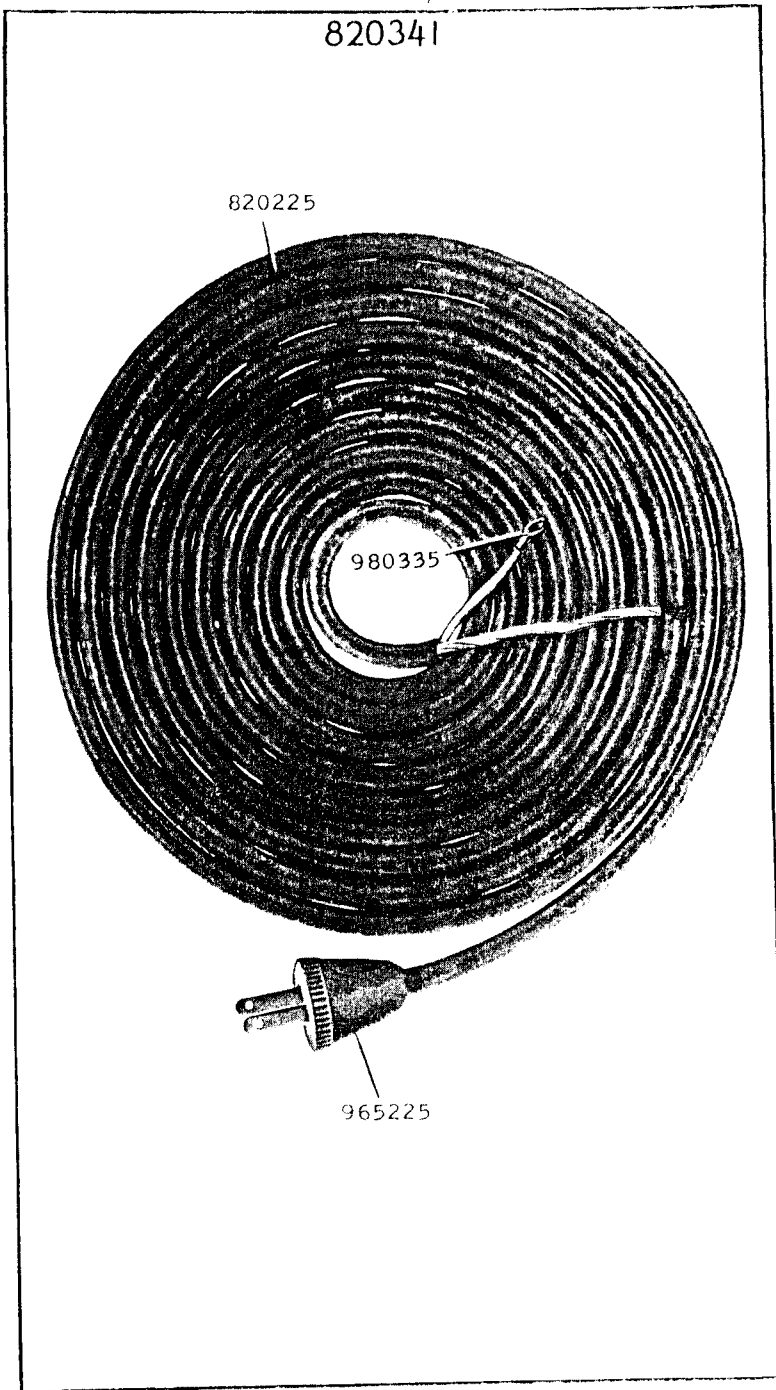

22959-1/3

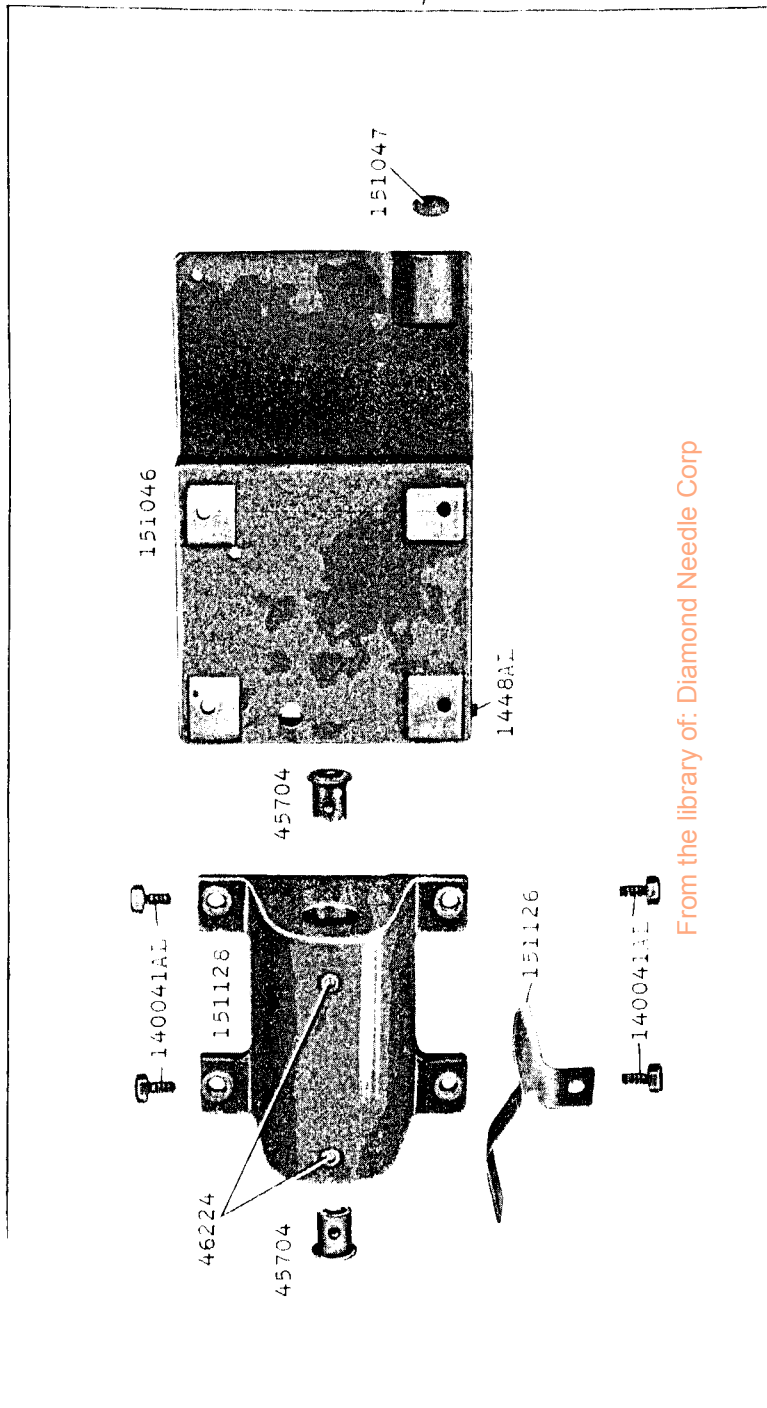

From the library of: Diamond Needle Corp